

NCEP GFS海溫錯置修改對 模式預報之影響

中央氣象局 資訊中心

林伯勳、洪景山

目錄

1. 研究目的
2. 海溫分析場修正方法介紹
3. 海溫分析場修正結果
4. 個案實驗結果探討
5. 結論

1. 研究目的

NCEP GFS、WRF海陸格點

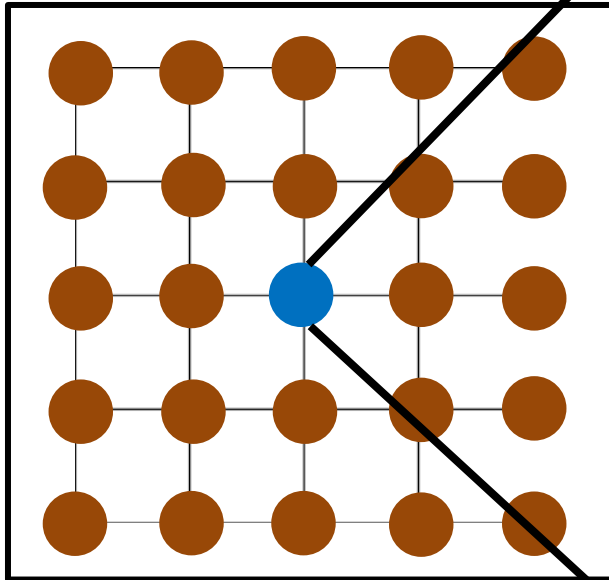

NCEP	WRF
海點	海點
陸點	陸點
海點	陸點
陸點	海點

NCEP GFS 海溫問題

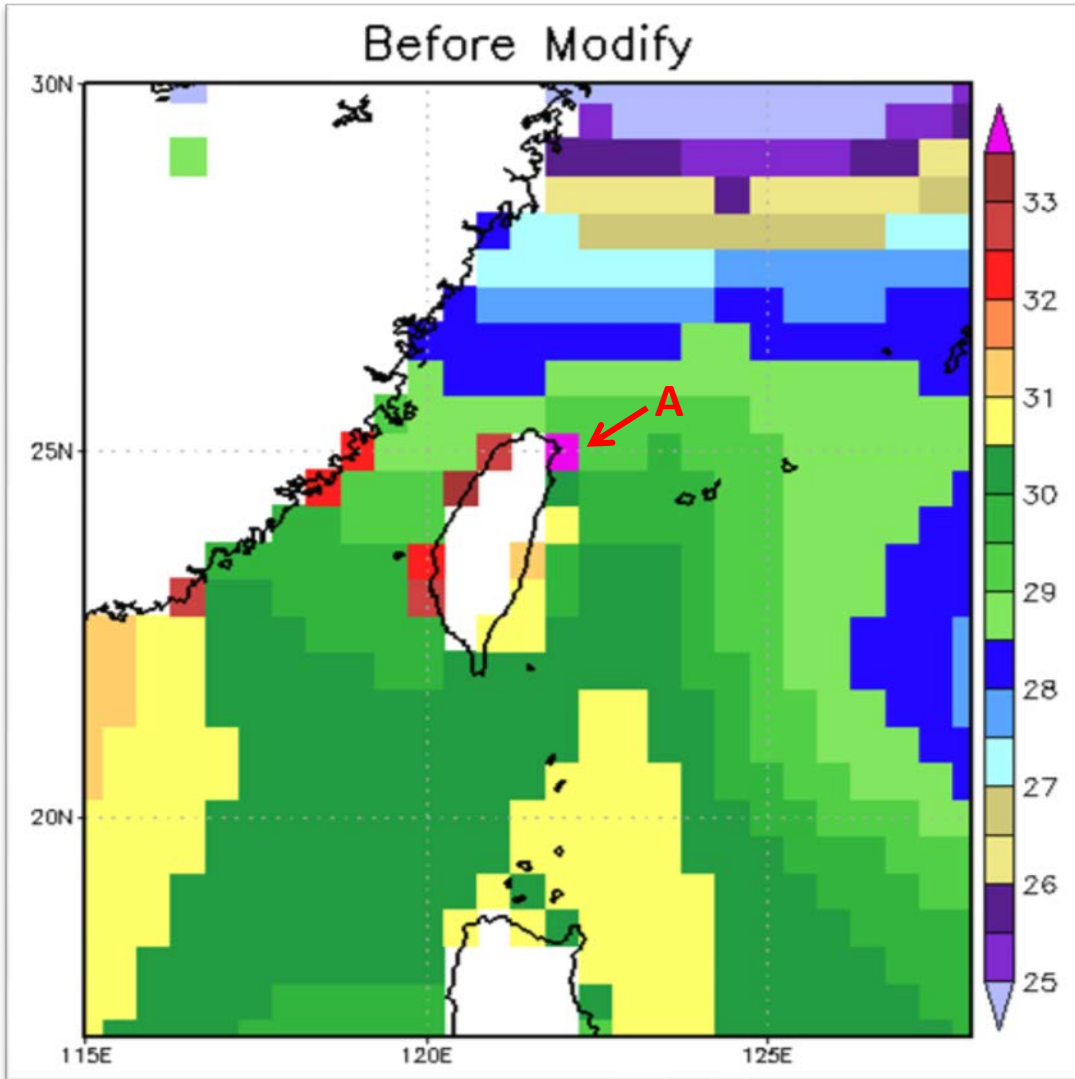

NCEP GFS初始場的部分格點海、陸點配置失當。例如A點，NCEP GFS定義它為海點，但其溫度卻是陸溫，若是WRF也定義該點為海點，WRF就會直接使用該點的溫度當海溫，就會造成誤把陸溫當海溫情況。

海、陸點配置失當會造成模式預報在海岸附近的海溫異常現象，進而嚴重影響近海的局部環流和降水預報。

Initial time : 14071006

WRF 模式海溫初始場

5 km

4 km

3 km

Sea Surface Temperature

Sea Surface Temperature

Sea Surface Temperature

SST_NoModify max=36.9246 min=26.4974

SST_NoModify max=37.0107 min=24.25

SST_NoModify max=36.8619 min=26.6164

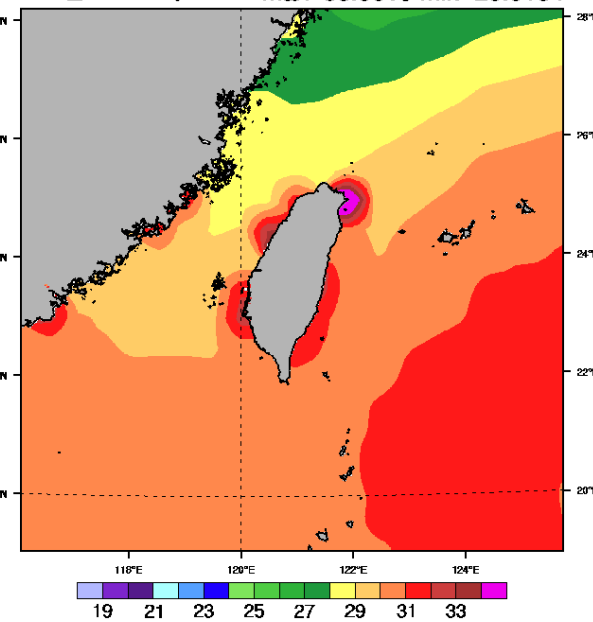
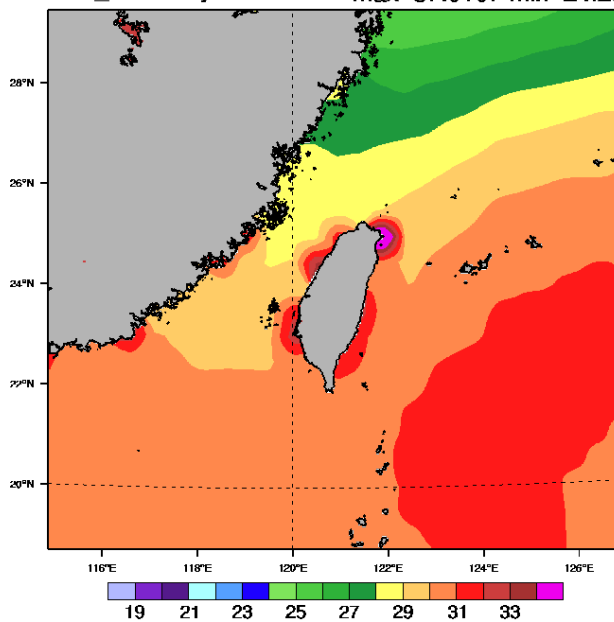
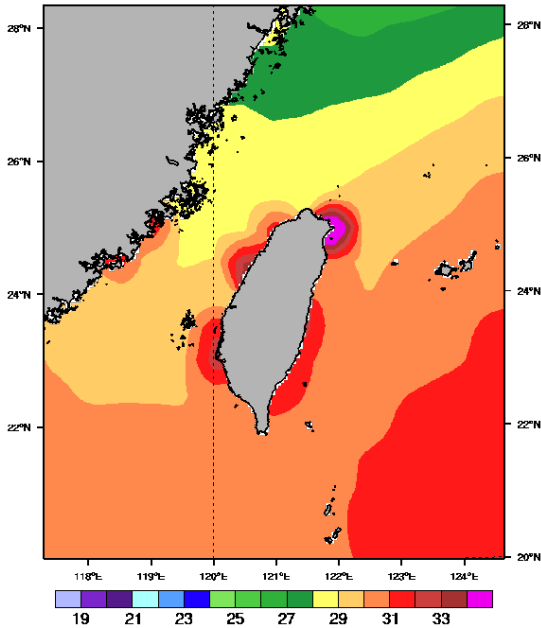

Initial time : 14071006

Fcst : 00~48 hr

Var : RAINNC

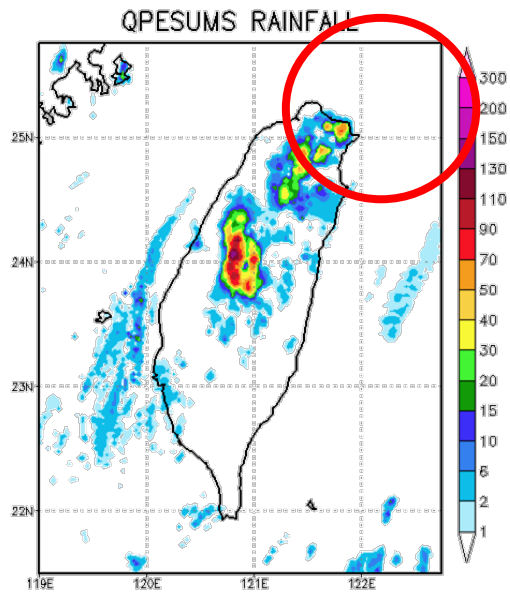

RAINNC

SST_NoModify

Fcst = 48

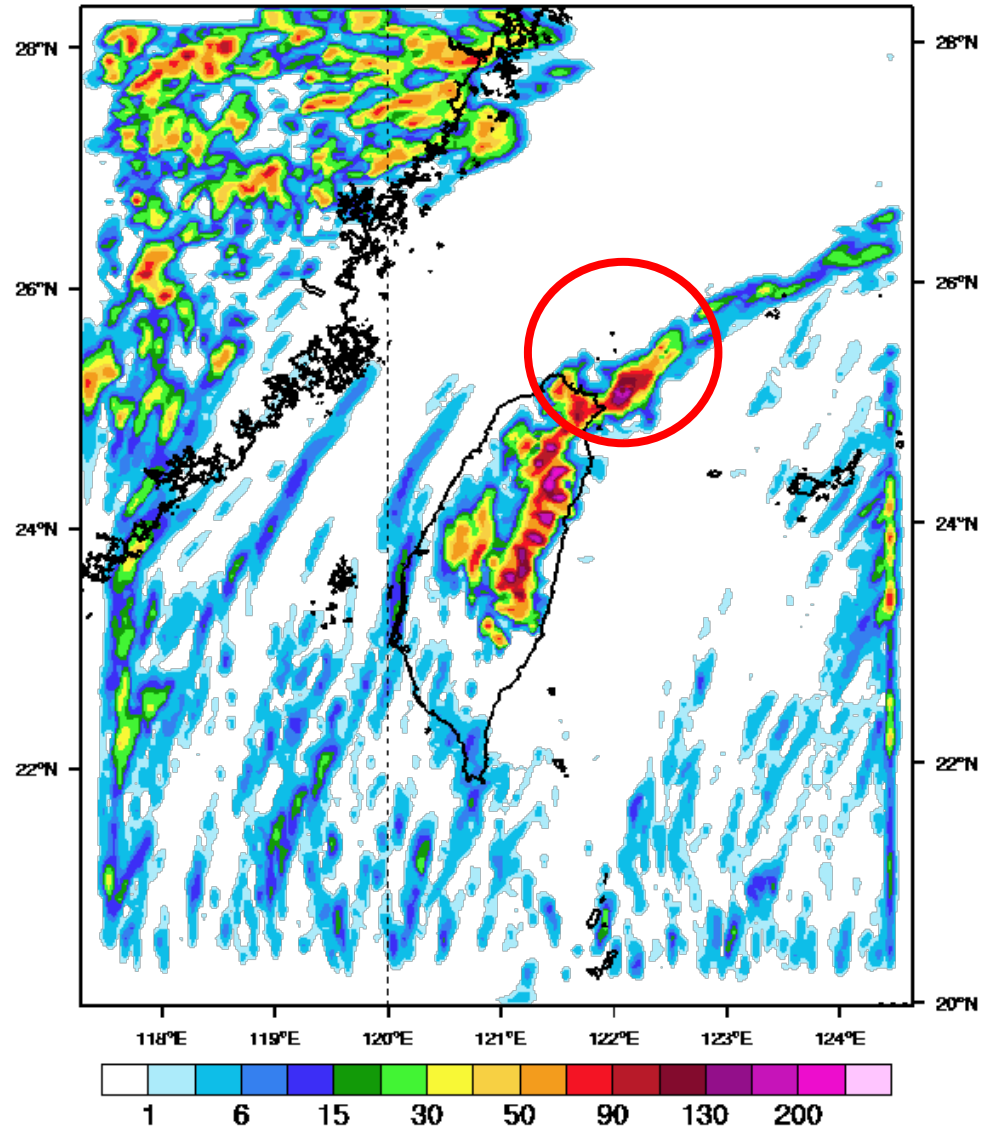

2. 海溫分析場修正方法介紹

NCEP GFS海溫修正方法

- 針對NCEP GFS海溫分析場做處理，因此可以免除區域模式解析度不同所帶來的麻煩。
- 要解決這個問題，我們必須對NCEP GFS沿岸海溫異常的格點進行修正。
- 以下以示意圖介紹此修正方法。

NCEP GFS海溫修正方法

- 海點
- 陸點
- ✘ special value

Step 1 :

對所有NCEP GFS格點進行判斷，只要與該格點緊鄰的8個格點中有出現1個以上（包含1個）的陸點，則該點的海溫值就改成special value，結果如圖2。

圖1

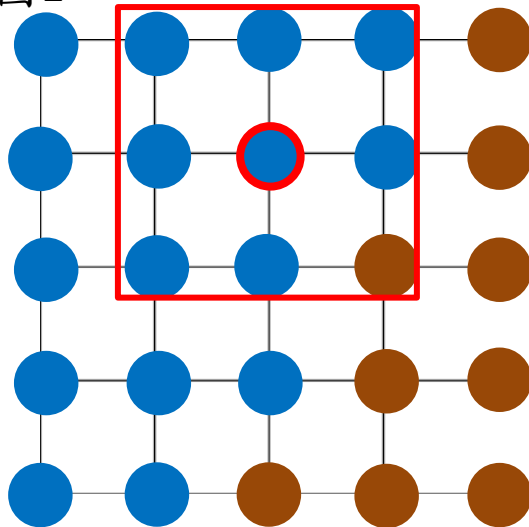

Step 1

圖2

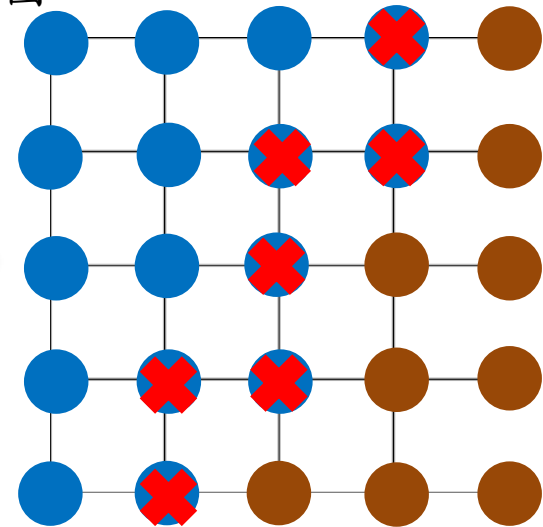

NCEP GFS海溫修正方法

- 海點
- 陸點
- ✘ special value

Step 2 :

對所有NCEP GFS格點進行判斷，只要該格點的海溫值為special value，就用與該格點緊鄰的8個格點中，landsea index為海點的海溫平均來取代該點的special value。例如圖3中， $A=(B+E)/6$

圖2

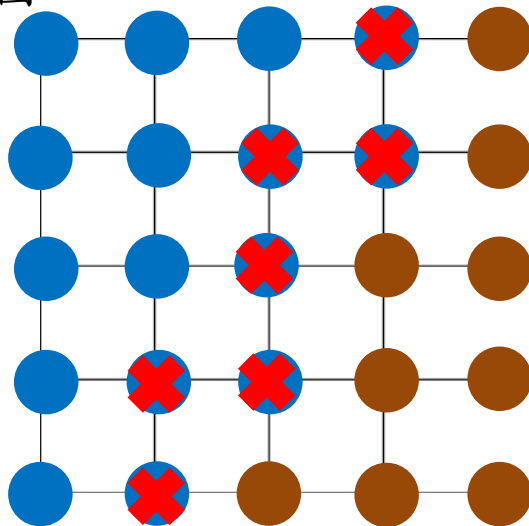

Step 2

圖3

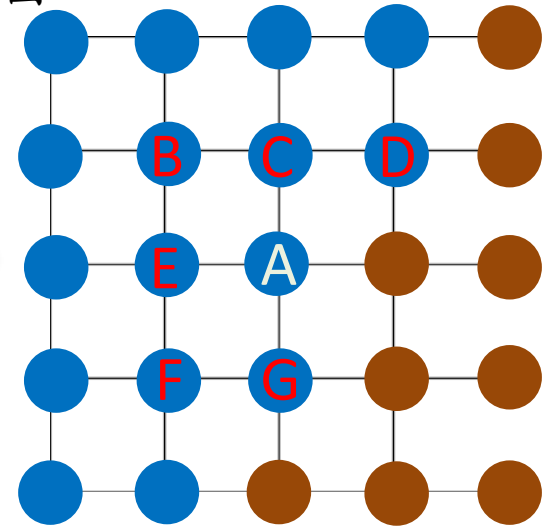

NCEP GFS海溫修正方法

- 海點
- 陸點
- ✘ special value

Step 3 :

- 經過step 2後，部分special value的格點會因為其周圍全部是陸點（例如內陸湖泊），所以無法進行修正，如圖3，則該點的值就用原來的海溫值取代。
- 海溫修正完成。

圖4

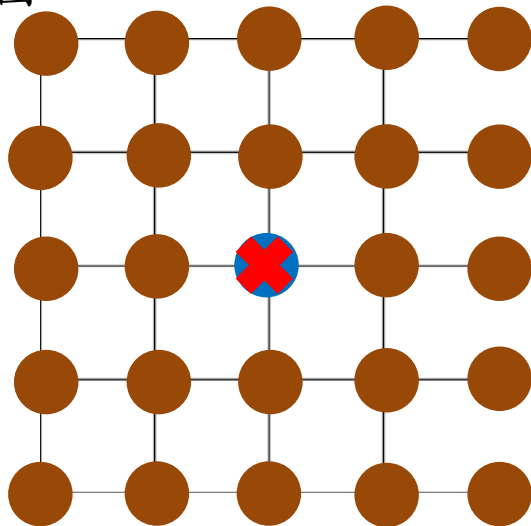

Step 3

圖4

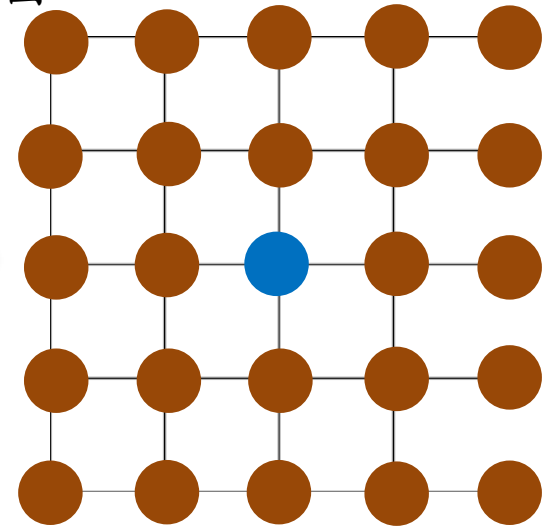

3. 海溫分析場修正結果

海溫分析場修正前 V.S 修正後

NCEP GFS 0.5°
2014071006 UTC

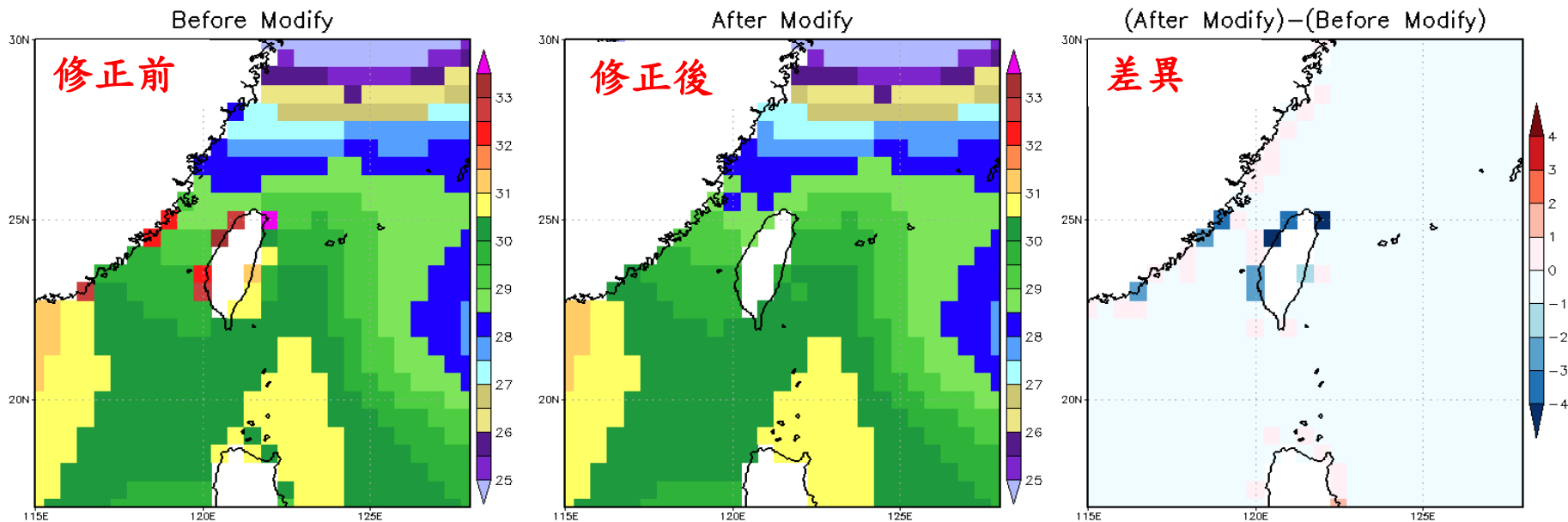

經過修正後，台灣及大陸東南沿海海溫明顯降低。
修正後的海溫分佈看起來較修正前合理。

模式解析度：5 km

Initial time : 14071006

WRF 模式海溫初始場

修正前

修正後

差異

Sea Surface Temperature

Sea Surface Temperature

Sea Surface Temperature

SST_NoModify max=36.9246 min=26.4974

SST_Modify max=31.2715 min=26.4896

DIFF max=0.579834 min=-7.61337

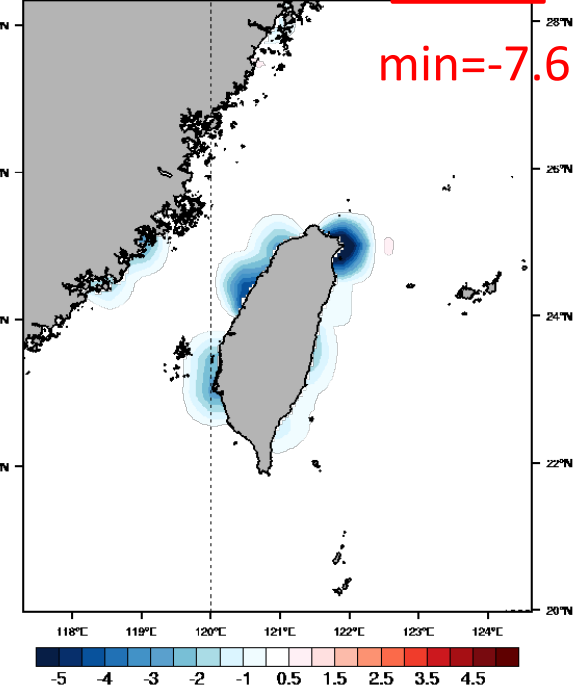
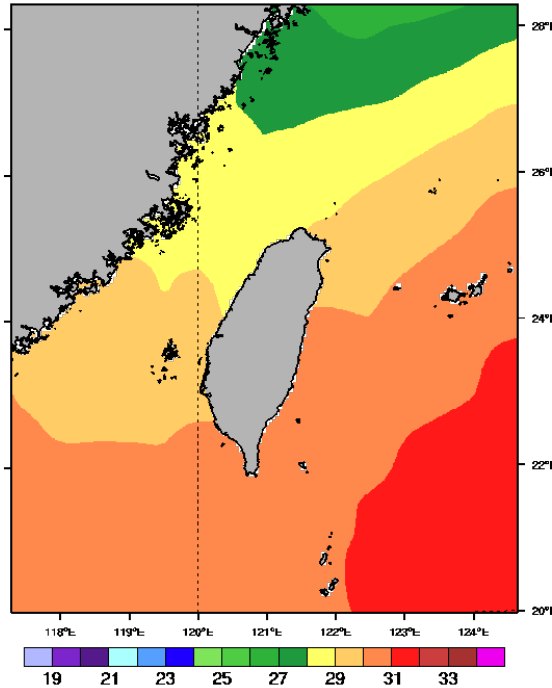
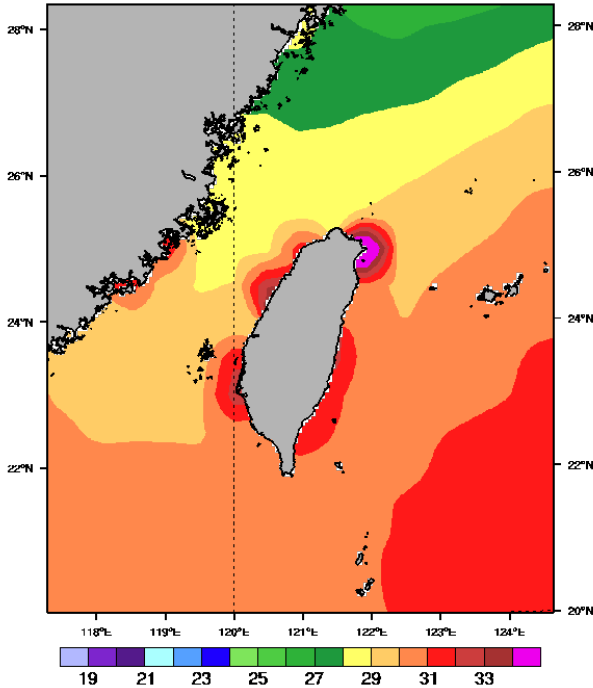

模式解析度：4 km

Initial time : 14071006

WRF 模式海溫初始場

修正前

修正後

差異

Sea Surface Temperature

SST_NoModify max=37.0107 min=24.25

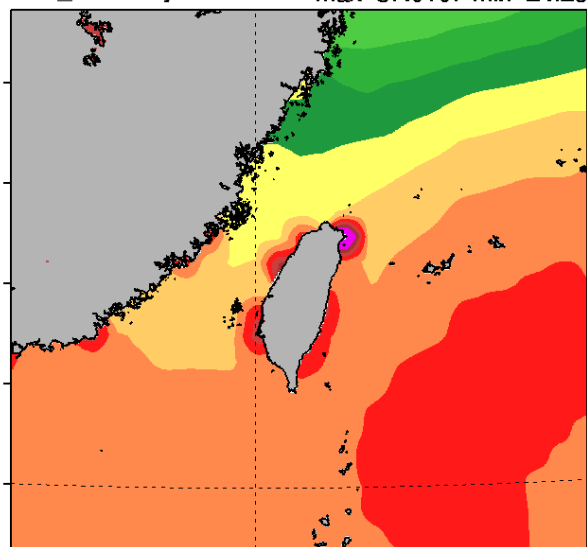

Sea Surface Temperature

SST_Modify max=32.95 min=24.5

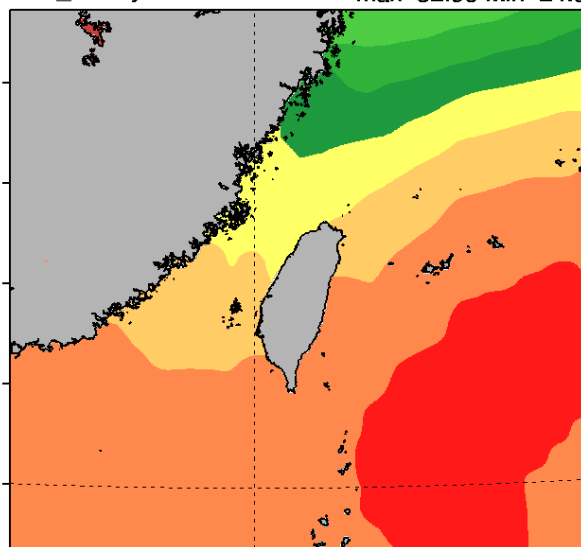

Sea Surface Temperature

DIFF max=0.577545 min=-7.68405

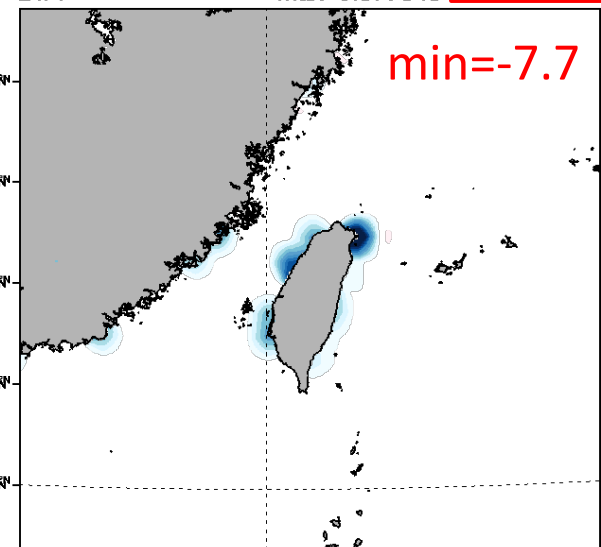

19 21 23 25 27 29 31 33

19 21 23 25 27 29 31 33

-5 -4 -3 -2 -1 0.5 1.5 2.5 3.5 4.5

模式解析度：3 km

Initial time : 14071006

WRF 模式海溫初始場

修正前

修正後

差異

Sea Surface Temperature

SST_NoModify max=36.8619 min=26.6164

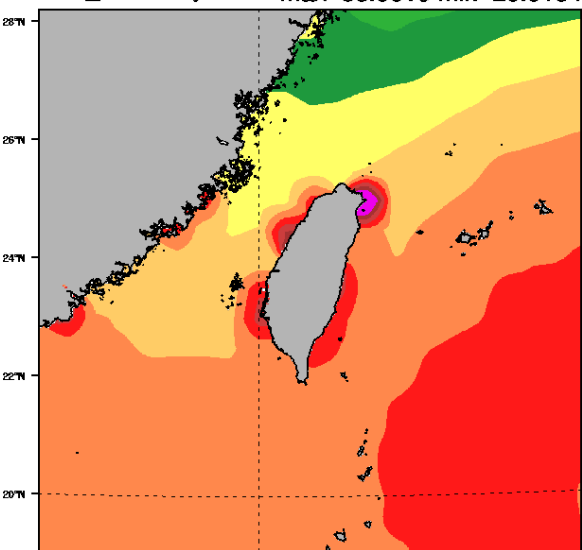

Sea Surface Temperature

SST_Modify max=32.95 min=26.6072

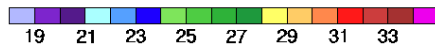
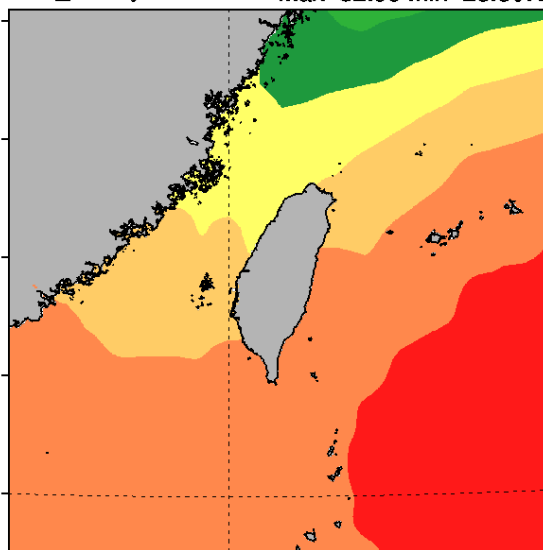

Sea Surface Temperature

DIFF max=0.579865 min=-7.53598

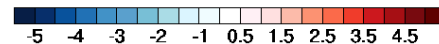
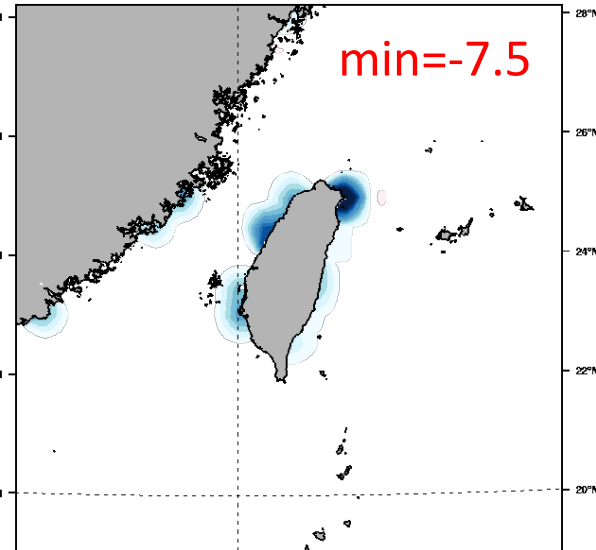

4. 個案實驗結果探討

Initial time : 14071006

Var : LH

SST_NoModify

SST_Modify

DIFF

Fcst : 12 hr

Valid time : 14071018

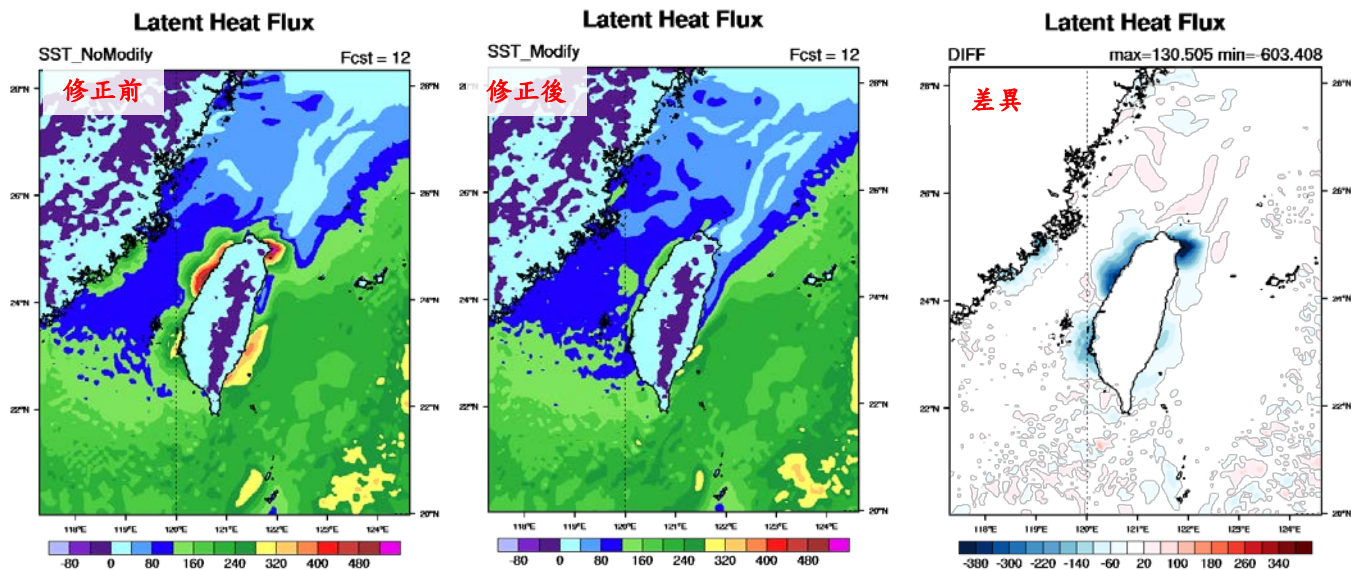

Fcst : 24 hr

Valid time : 14071106

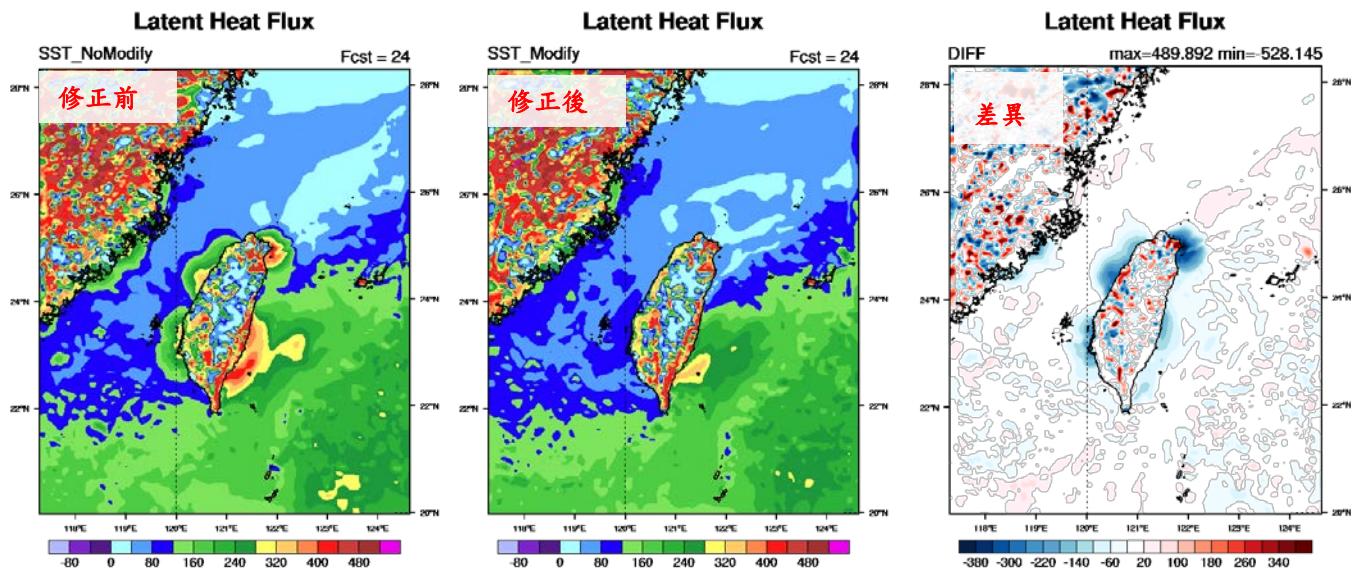

Initial time : 14071006

Var : HFX

SST_NoModify

SST_Modify

DIFF

Fcst : 12 hr

Valid time : 14071018

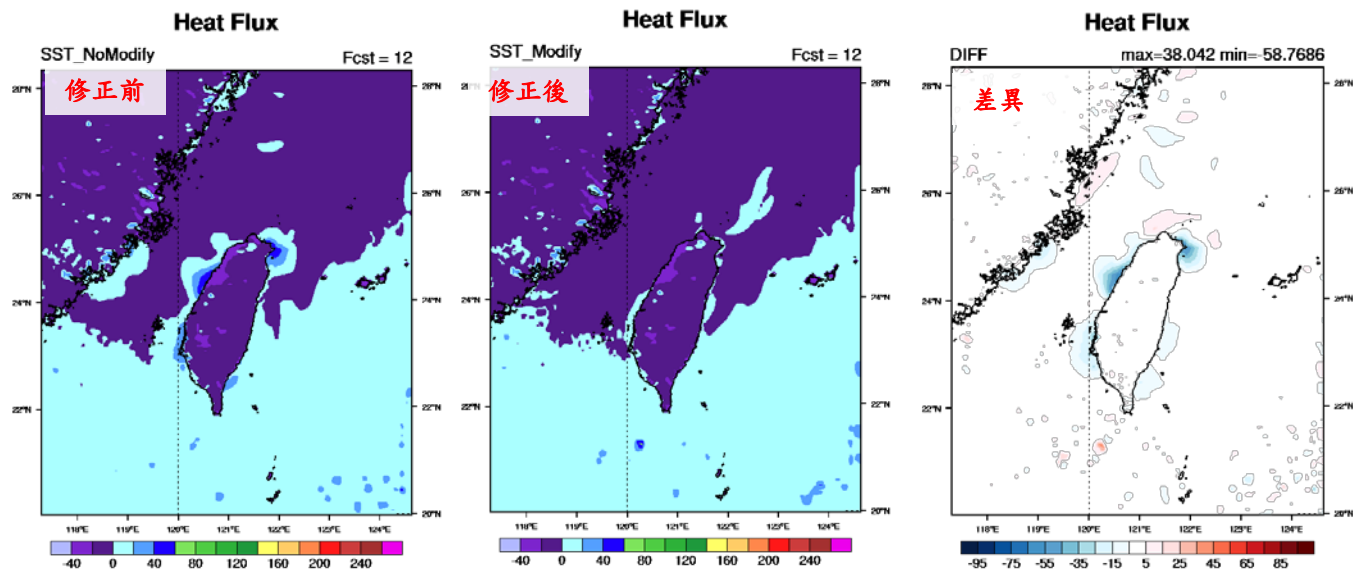

Fcst : 24 hr

Valid time : 14071106

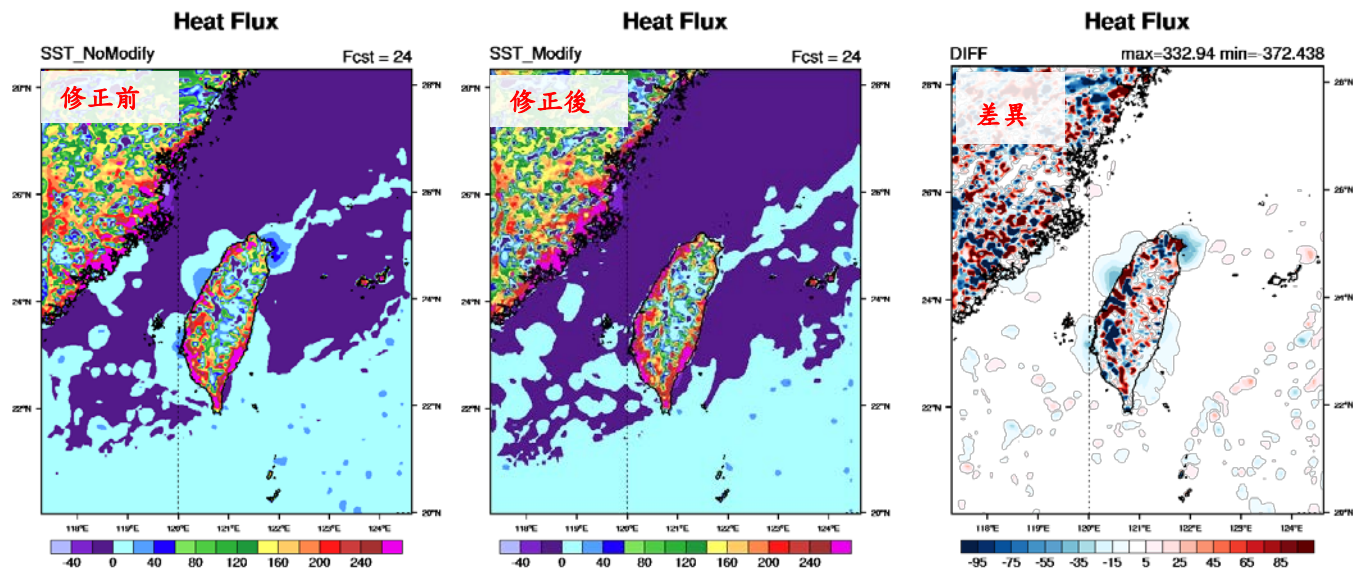

Initial time : 14071006

Var : Q2

SST_NoModify

SST_Modify

DIFF

Fcst : 12 hr

Valid time : 14071018

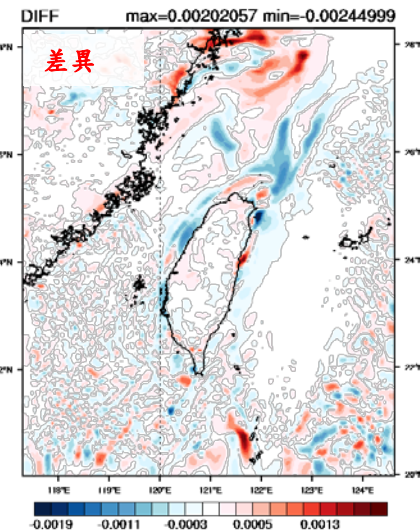
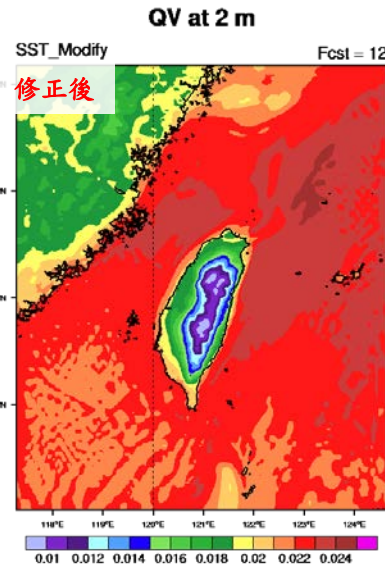
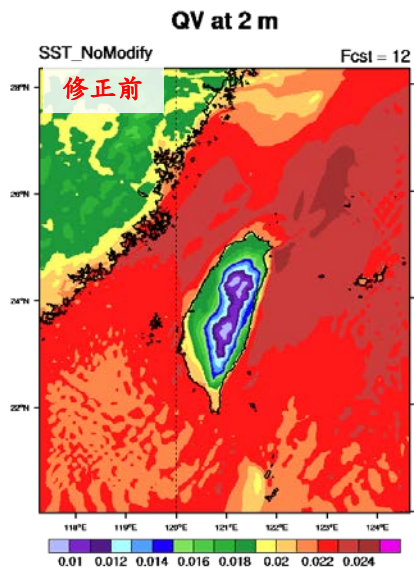

Fcst : 24 hr

Valid time : 14071106

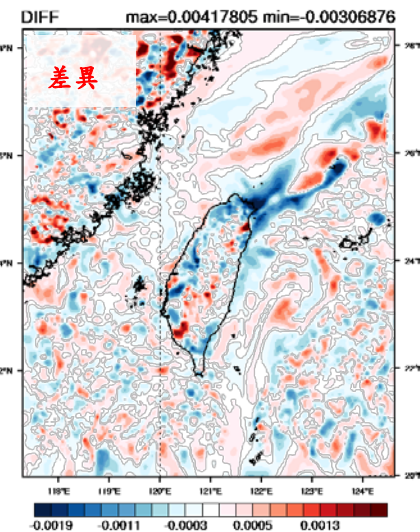
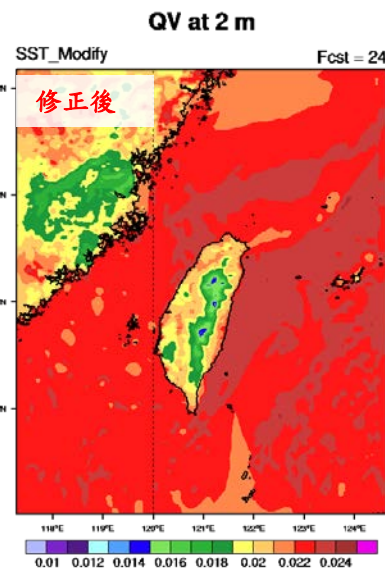
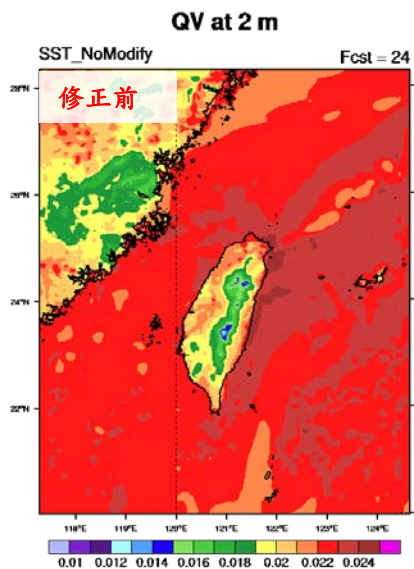

Initial time : 14071006

Var : T2

Fcst : 12 hr
Valid time : 14071018

SST_NoModify

SST_Modify

DIFF

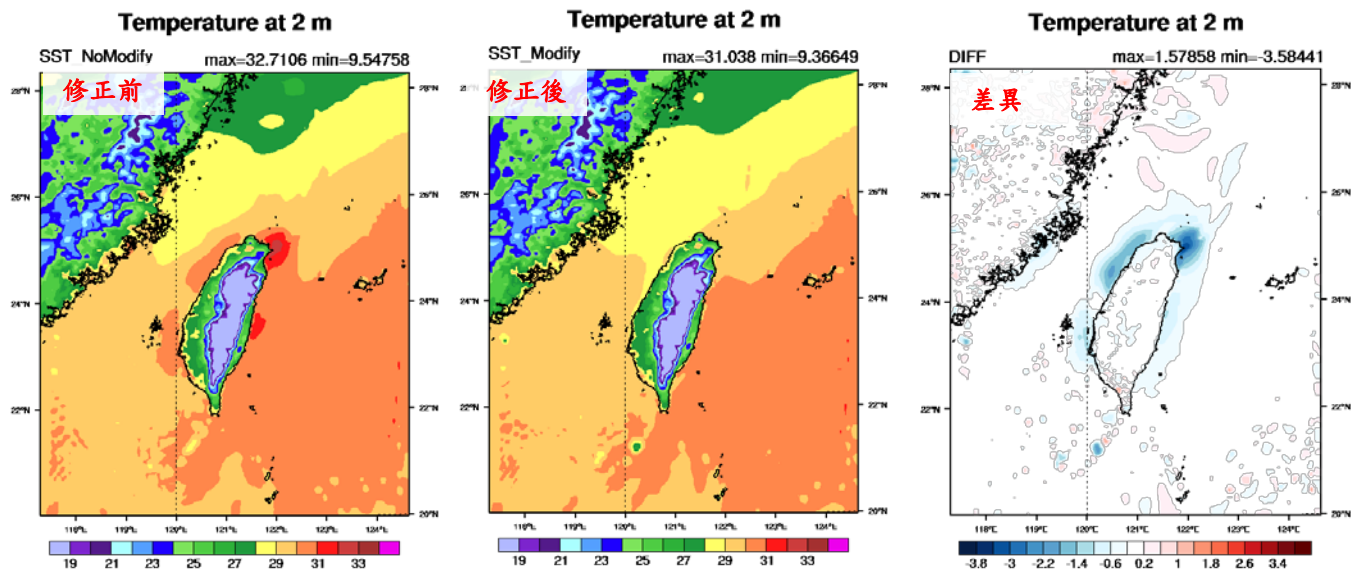

Fcst : 24 hr
Valid time : 14071106

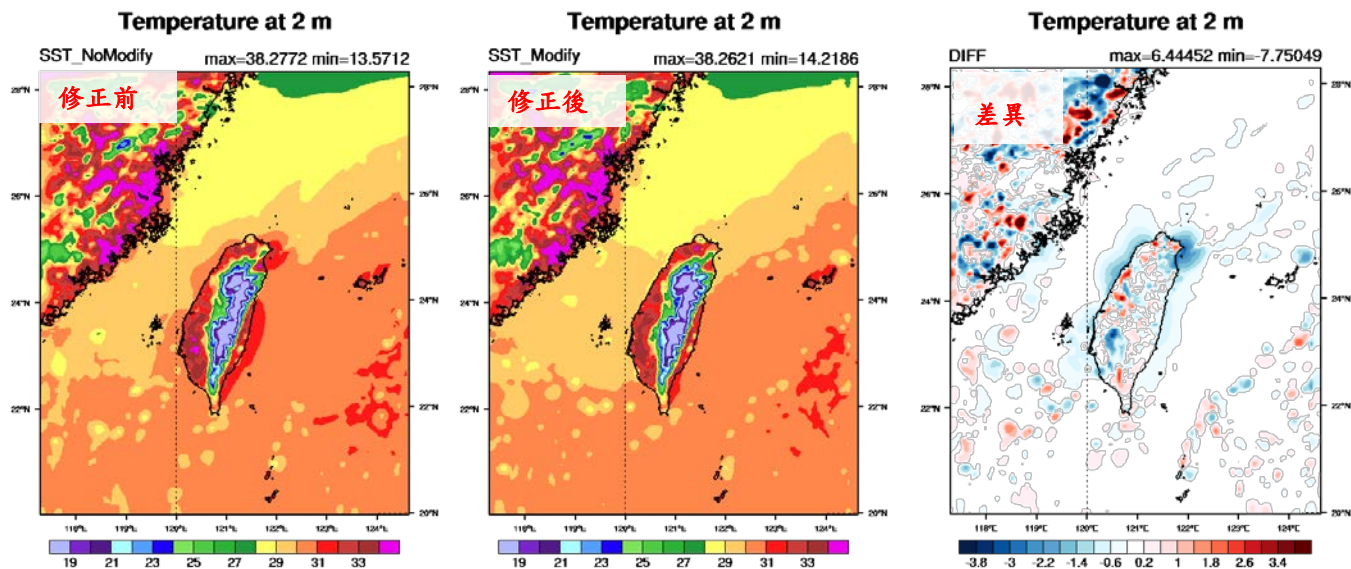

Initial time : 14071006

Var : PBLH

SST_NoModify

SST_Modify

DIFF

Fcst : 12 hr

Valid time : 14071018

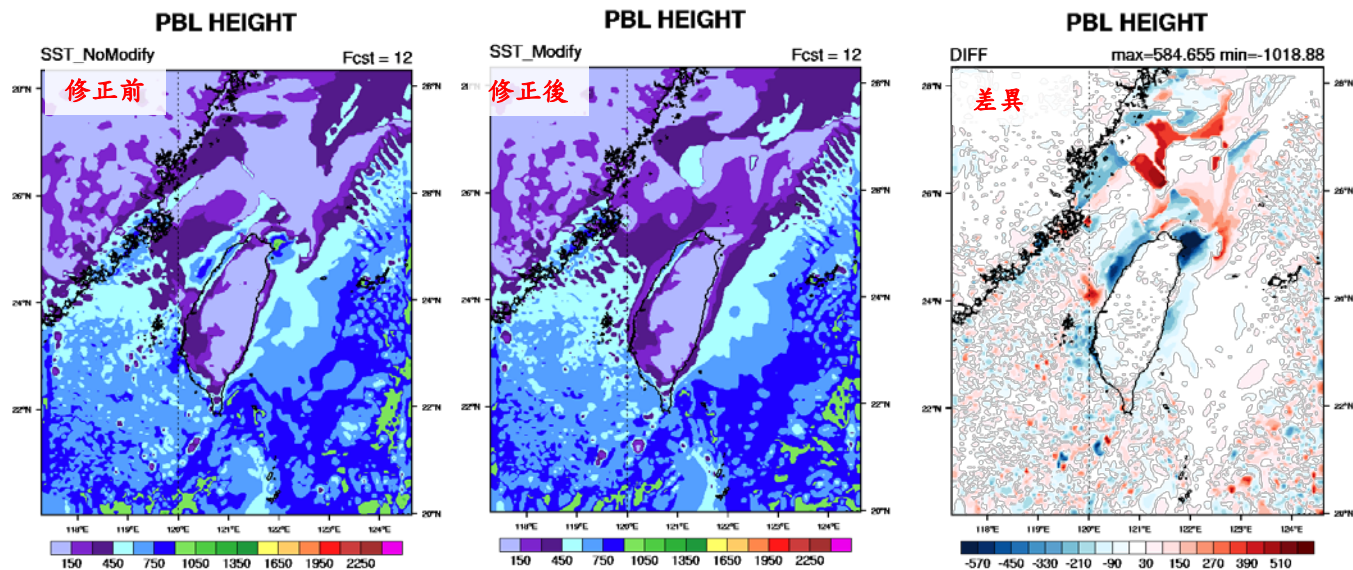

Fcst : 24 hr

Valid time : 14071106

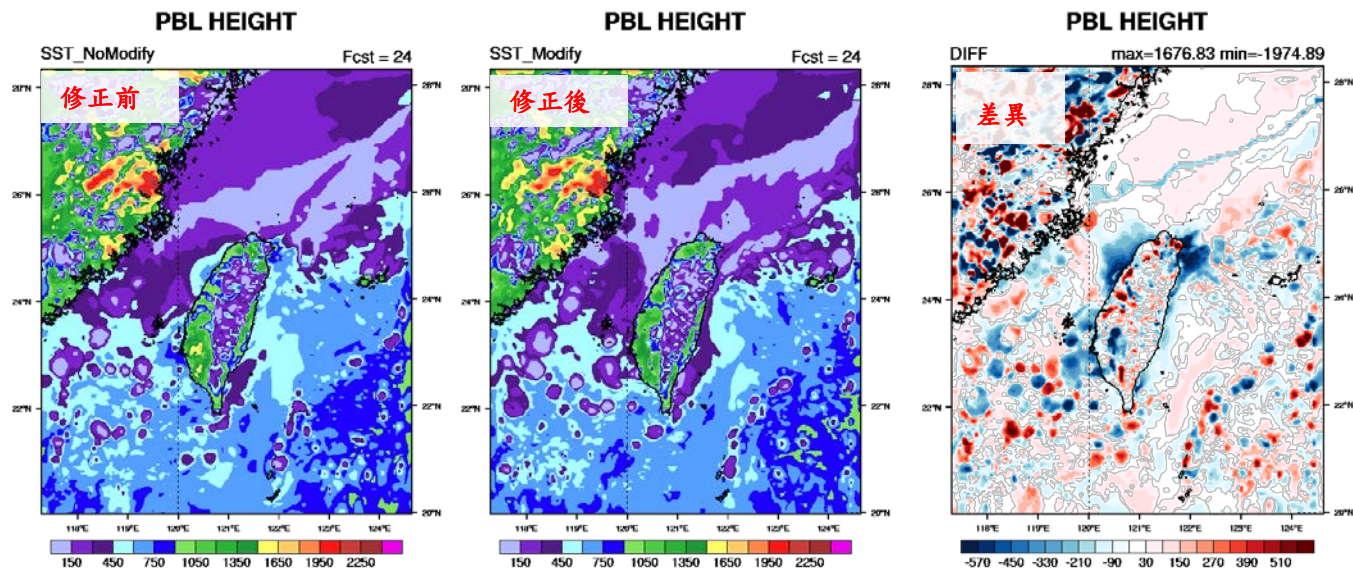

5. 結論

Initial time : 14071006

Fcst : 00~48 hr

Var : RAINNC

經過海溫修正後，模式對於台灣
東北部海域累積雨量高估的情況
明顯被修正

QPESUMS RAINFALL

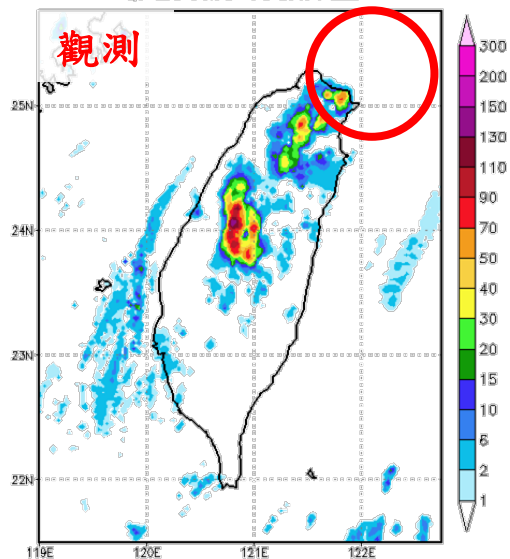

RAINNC

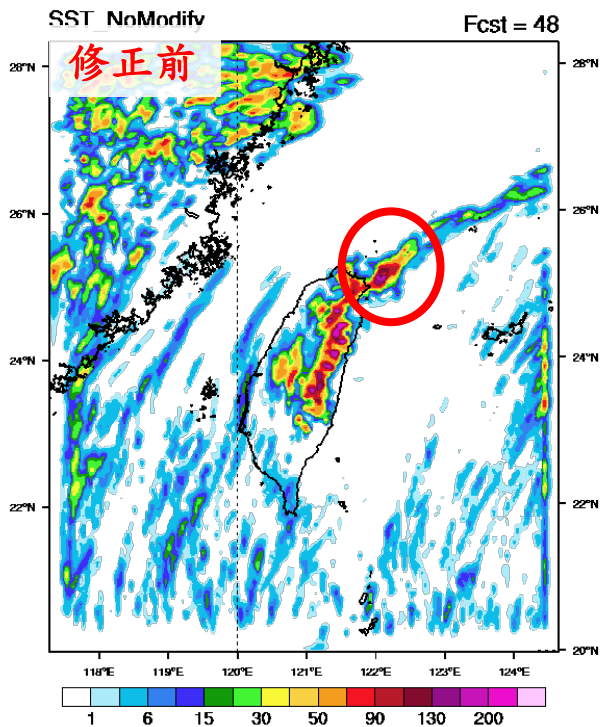

RAINNC

